

WiFi & RF LED Dimmer Kit

Model No.: WT1+R11

Tuya APP cloud control/2 Channels/ Push-Dim/DC power socket input/Wireless remote control

Features

- Used for control single color LED strip.
- DC power socket input and 2 channel constant voltage output.
- Tuya APP cloud control, support on/off, color temperature and brightness adjust, delay turn on/off light, timer run, scene edit function.
- Compatibility with RF 2.4G dimming remote control.
- User need set DIM light type by press key before Tuya APP network connection.
- Connect with external push switch to achieve on/off and 0-100% dimming function.
- Light on/off fade time 3s selectable.

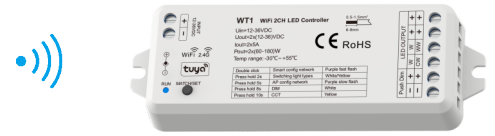

FC CE RoHS EMC LVD RED

Technical Parameters

Input and Output		LED Remote's Input and Output		Safety and EMC	
Input voltage	12-36VDC	Output signal	RF(2.4GHz)	EMC standard (EMC)	ETSI EN 301 489-1 V2.2.3 ETSI EN 301 489-17 V3.2.4
Output voltage	2 x (12-36)VDC	Working voltage	3VDC(CR2032)	Safety standard(LVD)	EN 62368-1:2020+A11:2020
Output current	2CH,5A/CH	Working current	<5mA	Radio Equipment(REDE)	ETSI EN 300 328 V2.2.2
Output power	2 x (60-180)W	Standby current	<10µA	Certification	CE,EMC,LVD,RED
Dimming signal	Tuya APP + RF + Push Dim	Standby time	<1 years	Environment	
Dimming curve	Logarithmic	Remote distance	30m(Barrier-free space)	Operation temperature	Ta: -30 °C ~ +55 °C
PWM Frequency	2000Hz (default)				

Mechanical Structures and Installations

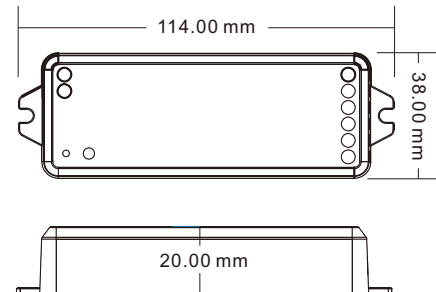
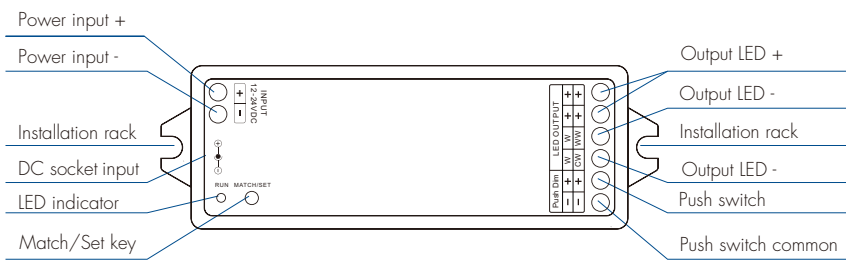

Remote function

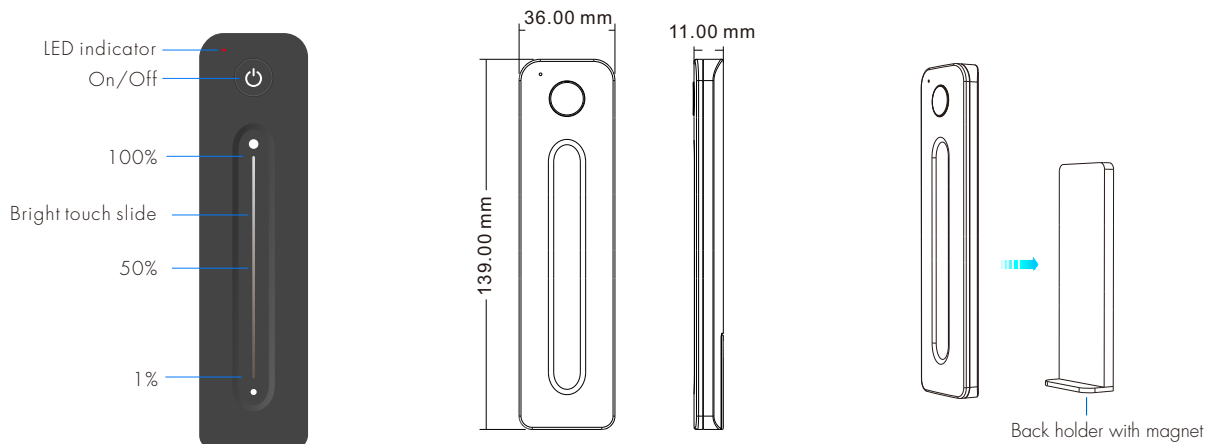

System wiring

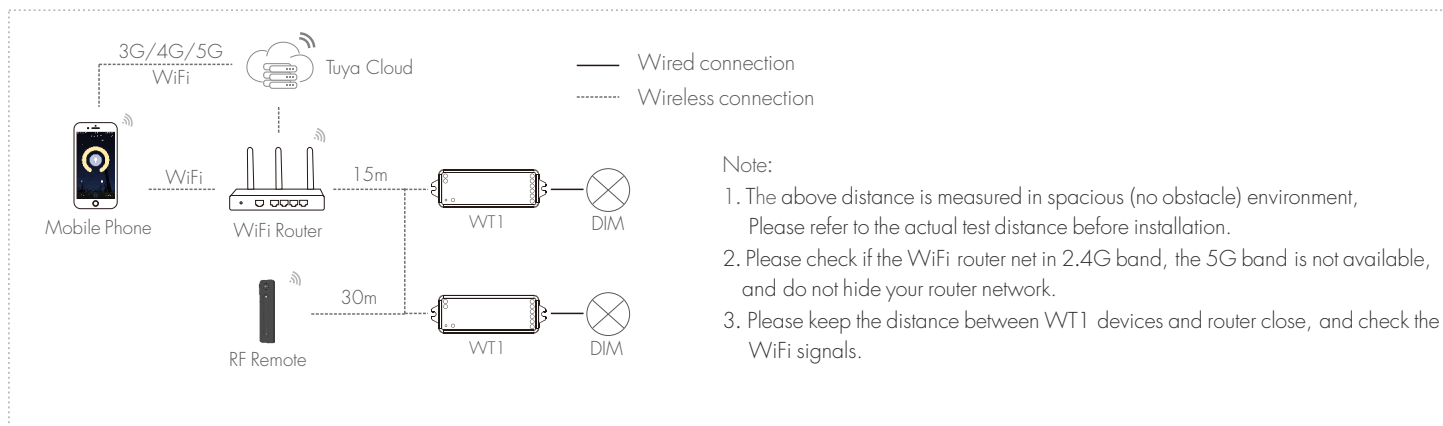

Wiring Diagram

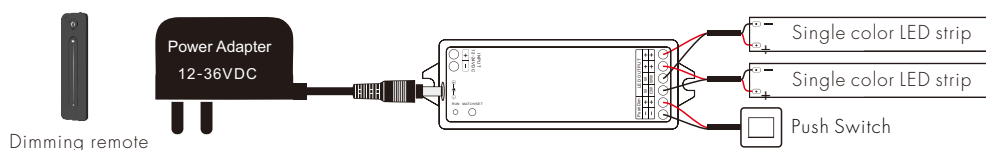

Press and hold match/set key for 8s, until the RUN LED indicator turn white, then release, the controller will become DIM type, then do smart config by tuya APP, or short press match key to match with dimming RF remote.

- Note:
1. User can connect constant voltage power supply or power adapter as power input.
 2. Switch off the power, then switch on power, repeat again. Immediately short press match key 3 times, the light on/off time will change between 3s and 0.5s.

Push Dim

DIM Single color	Click	ON/OFF
	Double Click	Turn on at 100% or 10% (night light) and vice-versa
	Long press(>1s) from OFF	Dimming UP/DOWN
	Long press(>1s) from ON	Dimming UP/DOWN

Tuya APP network connection

Push twice Match/Set key fastly, or when press and hold Match/Set key for 8s to set DIM light type: Clear previous network connection, enter Smart config mode, the purple LED indicator flash fastly, the output LED will flash 10 times.

Press and hold Match/Set key for 5s: Clear previous network connection, enter AP config mode, the purple LED indicator flash slowly. If smart config failed, please try AP config.

Repeat power on and off for 5 consecutive times, also clear previous network connection, enter Smart config mode, the output LED will flash 10 times.

If Tuya APP network connection succeed, the RUN LED indicator will stop flash purple, and turn corresponding light type color (White: DIM). and in Tuya APP, you can find DIM device.

Tuya APP interface operation:
Touch brightness slide to adjust brightness.

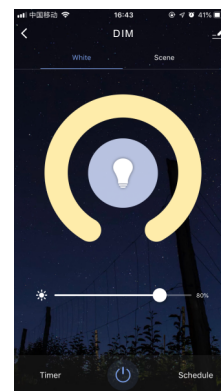

Match remote control

End user can choose the suitable match/delete ways. Two options are offered for selection:

Use the WT1's Match key

Match:
Short press match key of WT1, immediately press on/off key on the remote.
The LED indicator fast flash a few times means match is successful.

Delete:
Press and hold match key of WT1 for 5s to delete all match,
The LED indicator fast flash a few times means all matched remotes were deleted.

Use Power Restart

Match:
Switch off the power of WT1, then switch on power, repeat again.
Immediately short press on/off key 3 times on the remote.
The light blinks 3 times means match is successful.

Delete:
Switch off the power of WT1, then switch on power, repeat again.
Immediately short press on/off key 5 times on the remote.
The light blinks 5 times means all matched remotes were deleted.