

LED Intelligent Driver (constant voltage)

- Dimming interface: DMX512/RDM, Push DIM
- Supports RDM remote device management protocol.
- Dimming range from 0-100%, LED start at 0.1% possible.
- With soft-on and fade in function, visual more comfortable.
- 0-100% flicker-free, High frequency exemption level.
- In line with the EU energy efficiency ERP directive, standby power consumption < 0.5W
- Innovative thermal management technology, intelligent power life protection.
- Over-heat / Over voltage / Over load / Short circuit protection, recover automatically.
- Fully-protected plastic housing with design of dismantlable end cover.
- Suitable for indoor I / II / III type lamps application.
- 5 years warranty (Rubycon capacitor).



Flicker-free
IEEE 1789
Achieve the exemption level.



Dimmable:
0.1%-100%

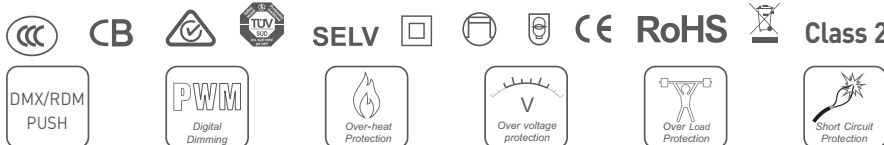

Specification

Model	LM-75-12-G1M2	LM-75-24-G1M2	LM-100-24-G1M2	
OUTPUT	Output Voltage	12Vdc	24Vdc	
	Output Voltage Range	12Vdc ±0.5Vdc	24Vdc ±0.5Vdc	
	Output Current	Max. 6.25A	Max. 3.125A	Max. 4.17A
	Output Power	Max. 75W		Max. 100W
	Output Power Range	0~75W		0~100W
	Strobe Level	High frequency exemption level.		
	Dimming Range	0-100%, dimming depth: Max. 0.1%		
	Overload Power Limitation	≥102%		
	Ripple & Noise	≤200mV	≤300mV	
PWM Frequency	3600Hz			
INPUT	Dimming Interface	DMX/RDM, Push DIM		
	Input Voltage	220-240Vac		
	Frequency	50/60Hz		
	Input Current	Max. 0.4A/230Vac		Max. 0.5A/230Vac
	Power Factor	PF>0.97/230Vac, at full load		
	THD	≤14% at 230Vac, at full load		
	Efficiency (typ.)	91%	92%	93%
	Standby Power Loss	<0.5W		
	Inrush Current(typ.)	Cold start 30A at 230Vac (twidth=1000µs measured at 50% (peak))		Cold start 45.2A at 230Vac (twidth=372µs measured at 50% (peak))
Control surge capability	L-N:2KV			
Leakage Current	Max. 0.5mA			
ENVIRONMENT	Working Temperature	ta: -20°C ~ 50°C tc: 80°C		
	Working Humidity	20 ~ 95%RH, non-condensing		
	Storage Temp., Humidity	-40°C ~ 80°C, 10~95%RH		
	Temp. Coefficient	±0.03%/°C (0-50°C)		
	Vibration	10~500Hz, 2G 12min./1cycle, period for 72min. each along X, Y, Z axes.		
PROTECTION	Over-heat Protection	Intelligently adjusting or turning off the output current if the PCB temperature ≥110°C, auto recovers.		
	Over Voltage Protection	Shut down the output when non-load voltage ≥13V, re-power on to recover after fault condition is removed.	Shut down the output when non-load voltage ≥26V, re-power on to recover after fault condition is removed.	
	Over Load Protection	Shut down the output when current load ≥102%, auto recovers.		
	Short Circuit Protection	Shut down automatically if short circuit occurs, auto recovers.		
SAFETY & EMC	Withstand Voltage	I/P-O/P: 3750Vac		
	Isolation Resistance	I/P-O/P: 100MΩ/500VDC/25°C/70%RH		
	Safety Standards	IEC/EN61347-1, IEC/EN61347-2-13		
	EMC Emission	EN55015, EN61000-3-2 Class C, IEC61000-3-3		
	EMC Immunity	EN61000-4-2,3,4,5,6,8,11 EN61547		
Strobe Test Standard	IEEE 1789			
OTHERS	Dimension	293×43×30mm(L×W×H)		
	Packing	296×44×33mm(L×W×H)		
	Weight(G.W.)	300g±10g		

* The driver is suitable for connecting resistor current-limiting LED fixture (e.g. LED strip). The inrush current will be dozens of times increased if connecting built-in constant current IC current-limiting LED fixtures, the driver will activate the overloaded protection (hiccup flickering). When you order, please remark controlling the constant current LED fixture (e.g. MR16 lamp, underground light, LED wall washer, constant current LED strip, etc.), then we can prepare the special programs.

Dimensions

Unit: mm

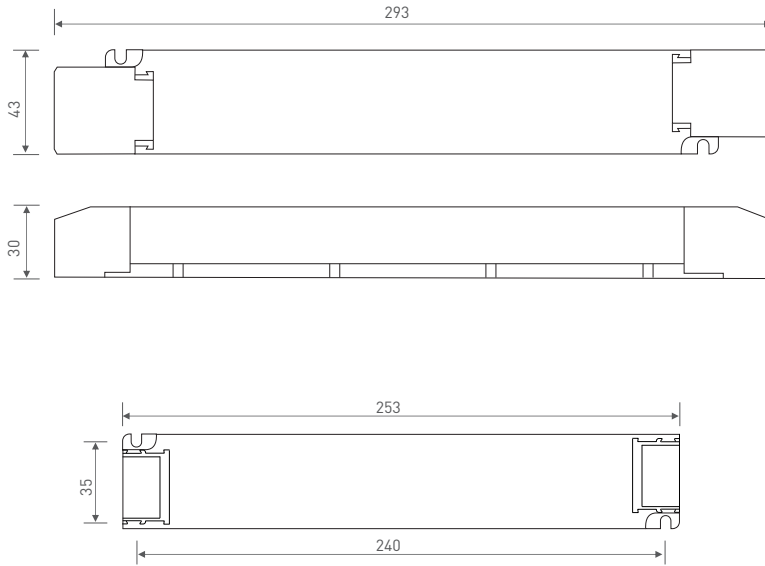

Wiring Diagram

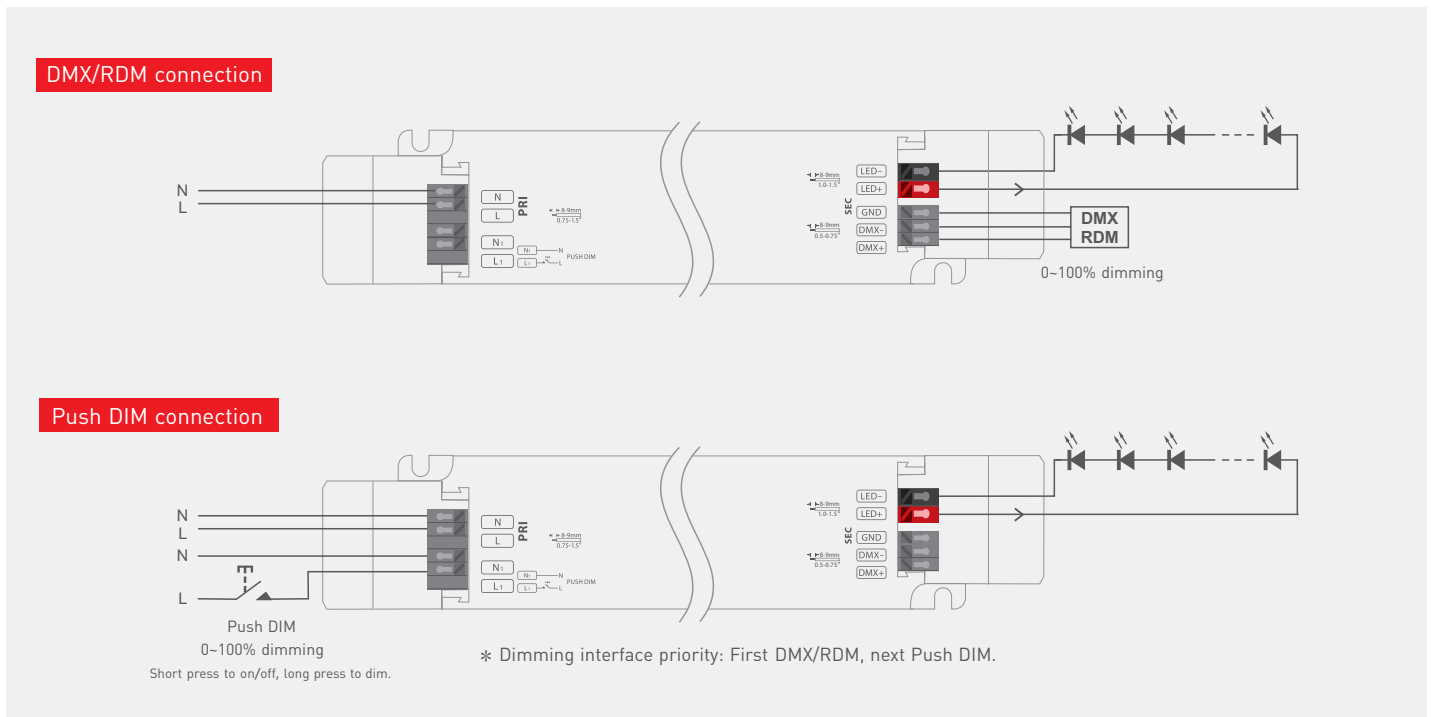

Push Dimming



Reset switch

- On/off control: Short press.
- Stepless dimming: Long press.
- With every other long press, the brightness goes to the opposite direction.
- Dimming memory: Brightness will be the same as previously adjusted when turning on again.

Application of Protective Cover

Wire pressing board:

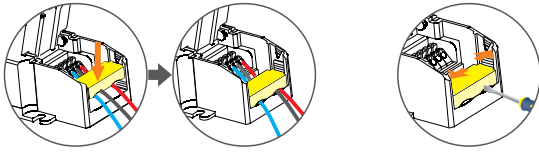

Push the wire pressing board to fix the wire.

Push outward the side plate, meanwhile use the tool to uninstall the wire pressing board.

Uninstall protective cover:

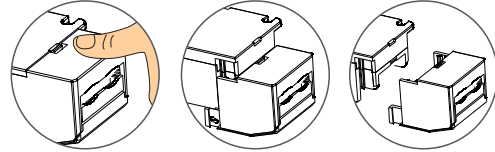

Break off the bottom left and right to remove the protective cover.

DMX Address Setting

The DMX driver can work with the address editor that complies with standard RDM protocol.

It is recommended to use LTECH's RDM editor (model WiFi-RDM01), which can achieve more functions such as remote browsing and parameter setting. Wiring diagram as below:

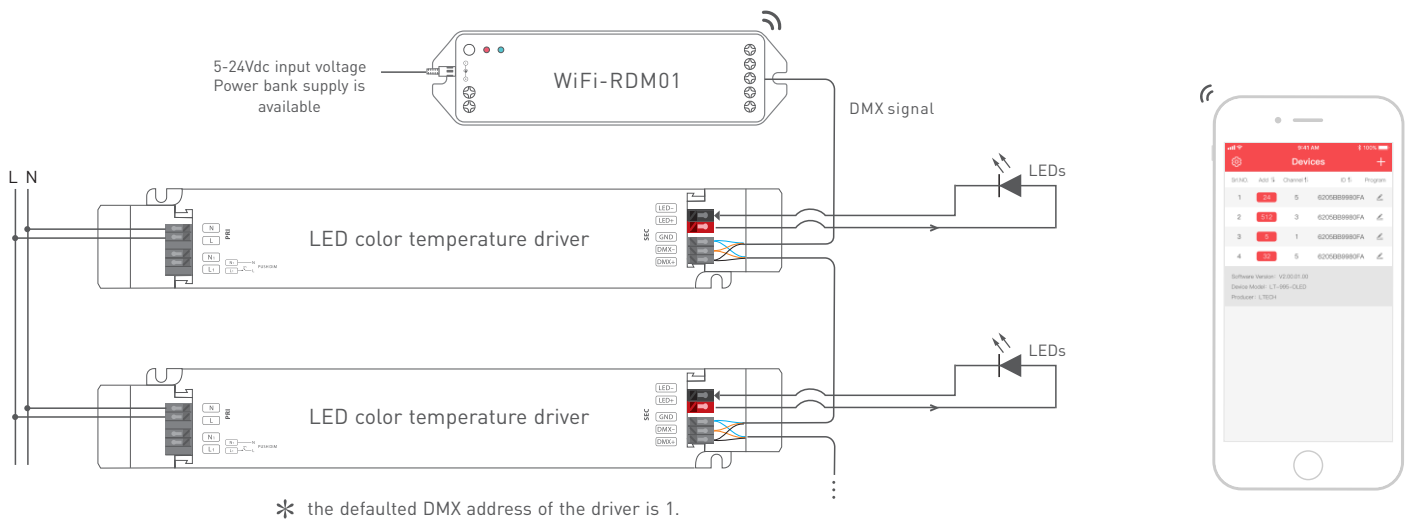

LTECH RDM editor App interface instruction

Download the App, setting the parameters after well connecting the RDM editor, please check the manual of WiFi-RDM01 for more details.

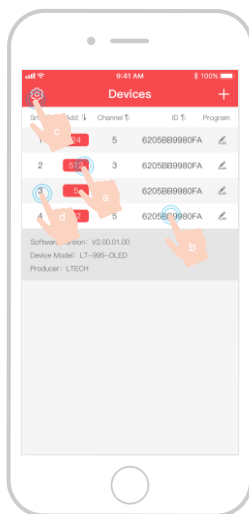

- a: Click "Add", edited the address in corresponding box.
- b: Click "ID", get more product details.
- c: Click "⚙️", enter setting interface
- d: Click "No.", issue the recognizing command.

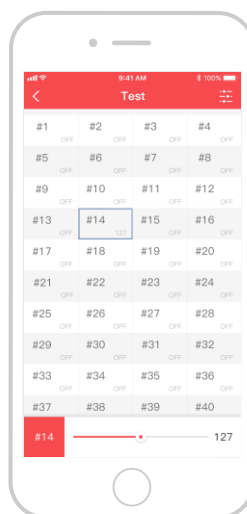

Test

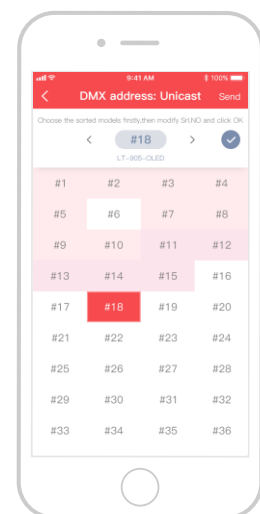

DMX address setting

Relationship Diagrams

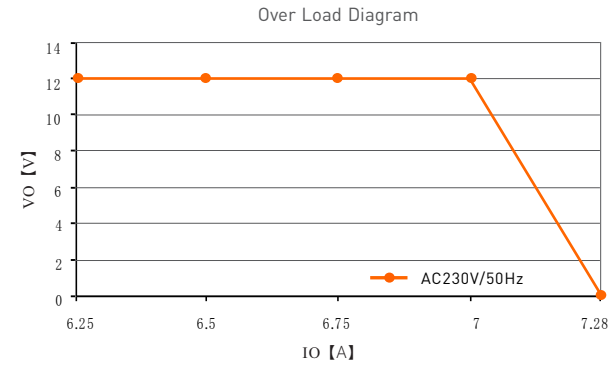
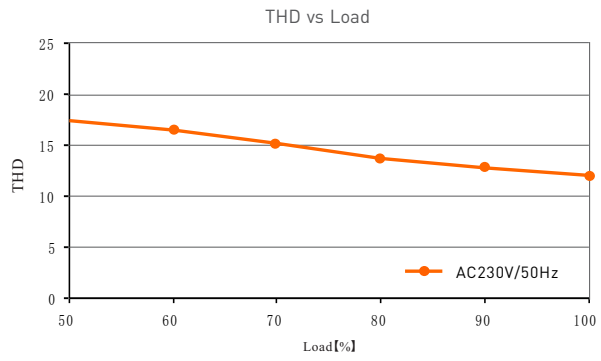
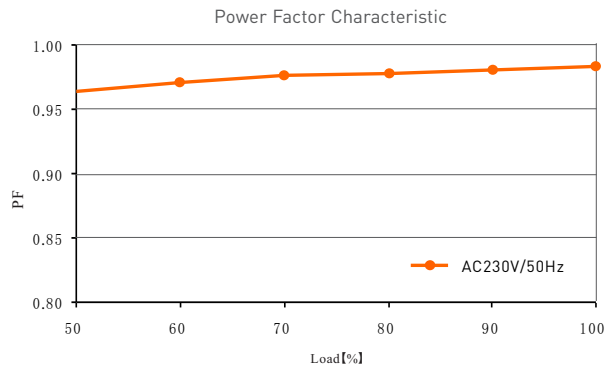
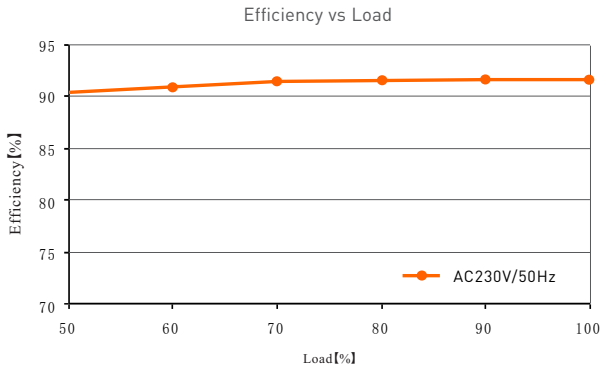

LM-75-12-G1M2

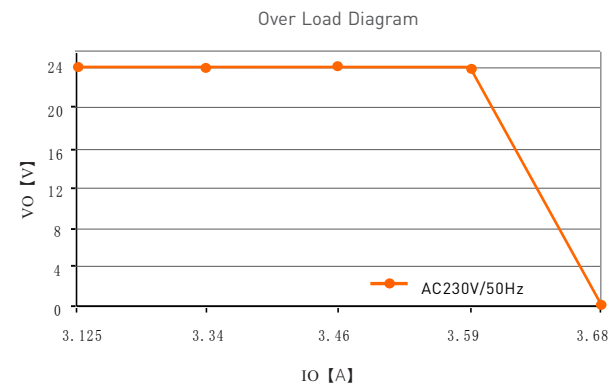
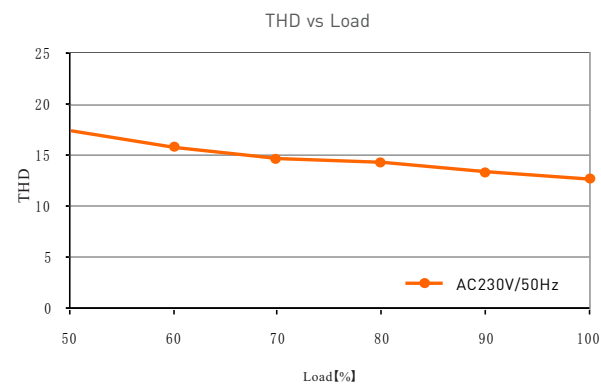
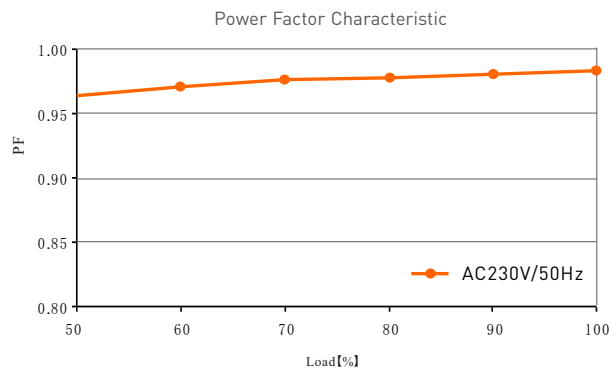
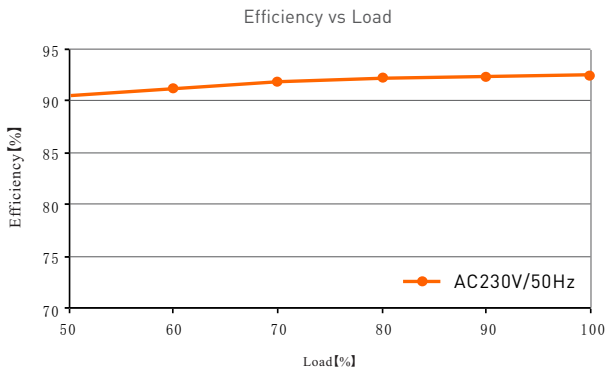

LM-75-24-G1M2

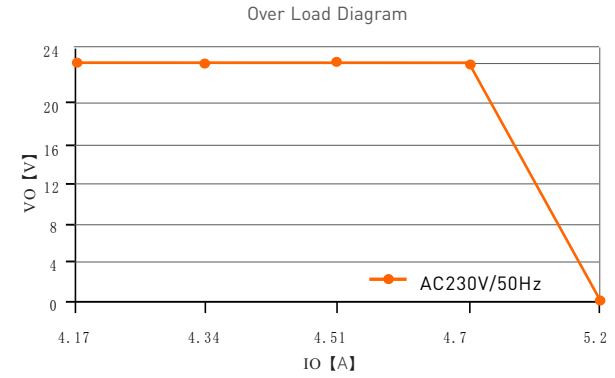
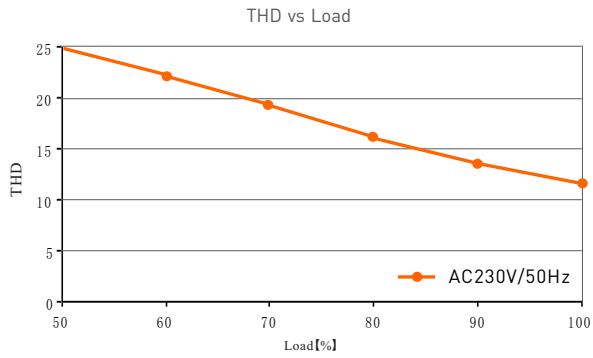
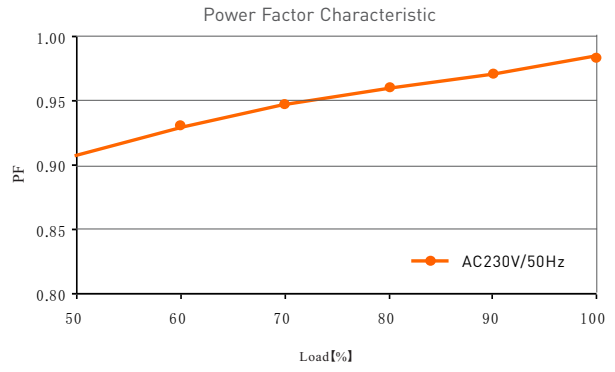
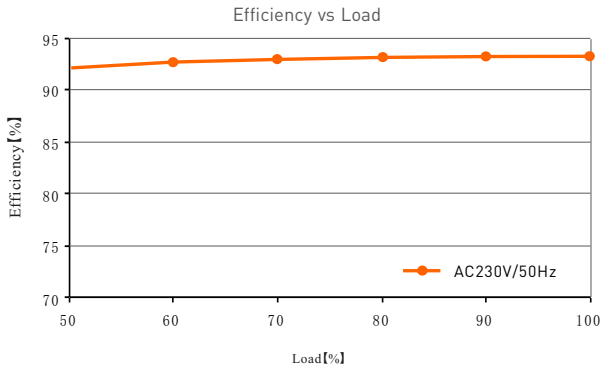

LM-100-24-G1M2

Flicker Test Form

IEEE 1789

Limit of Modulation in low risk area	
Waveform frequency of Optical output	limit [%]
$f \leq 8\text{Hz}$	0.2
$8\text{Hz} < f \leq 90\text{Hz}$	$0.025 \times f$
$90\text{Hz} < f \leq 1250\text{Hz}$	$0.08 \times f$
$f > 1250\text{Hz}$	Exemption assessment
Limit of Modulation in no effect area	
Waveform frequency of Optical output	limit [%]
$f \leq 10\text{Hz}$	0.1
$10\text{Hz} < f \leq 90\text{Hz}$	$0.01 \times f$
$90\text{Hz} < f \leq 3125\text{Hz}$	$(0.08/2.5) \times f$
$f > 3125\text{Hz}$	Exemption assessment (High frequency exemption)

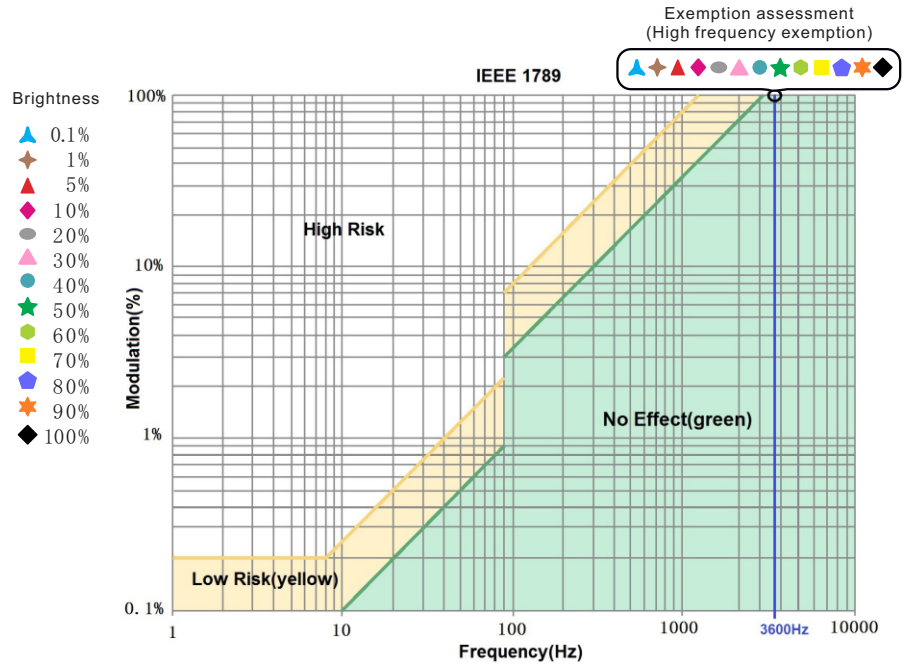

* No further notice if any changes in the manual. Product function depends on the goods. Please feel free to contact your supplier if any question.