

Product features

- Adopt wireless RF and wired DMX512 protocol 2 in 1 control mode, more flexible and convenient for project installation.
- Advanced RF wireless sync/zone control technology, make sure dynamic color modes synchronously among multiple drivers.
- Four zones can be combined arbitrarily, for example: zone 1 and zone 2 as a group, or zone 1, zone 3, zone 4 as a group, or all the 4 zones as a group.
- No limit the quantity of drivers in each zone, and all color modes keep synchronously.
- Support multiple panels linkage control, no quantity limitation.
- Touch keys with chord and LED indicator.
- Adopts capacitive touch control technology on full color wheel, make LED color selection more user-friendly.
- Compatible with remote and APP control with adding LTECH gateway.

Technical specs

Model	EX5	EX6	EX8	EX8S
Control type	Dimming	CT	RGBW	
Input voltage	100-240Vac			
Output signal	DMX512			
Wireless type	RF 2.4GHz			
Zone	4 zones			
Working temp.	-20°C~55°C			
Dimensions	L86×W86×H36(mm)			
Package size	L113×W112×H50(mm)			
Weight(G.W.)	225g			

Key functions

- * When blue indicator light of key is on, long press to turn on/off buzzer. When white indicator light of key is on, long press to match code.

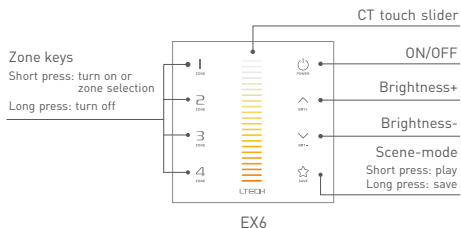
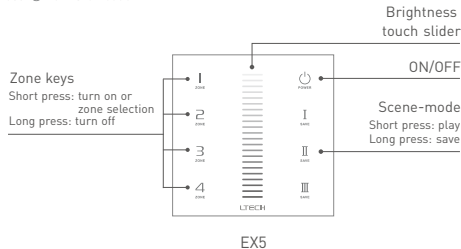

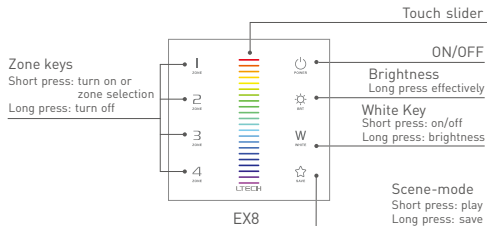

* White light only: press "W" key to turn on white light under OFF status.

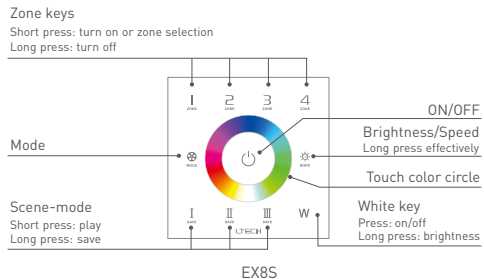

* White light only: press ⊕ key to choose black mode, then press W key for white light.

Mode

1. Static red
2. Static green
3. Static blue
4. Static yellow
5. Static purple
6. Static cyan
7. Static white
8. RGB jumping
9. 7 Colors jumping
10. RGB color smooth
11. Full-color smooth
12. Static black
(only close RGB)

Product size Unit: mm

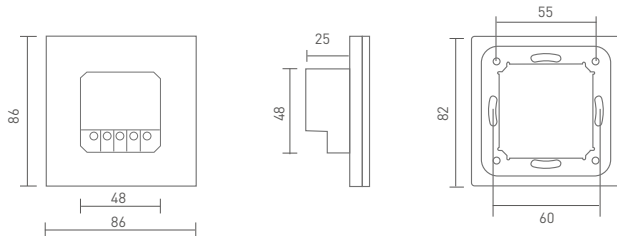

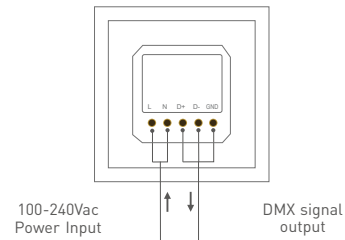

Terminals



Application composition

DMX512 control

- 

1. Touch panel + DMX driver + Lamp
- 

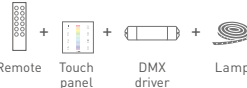
3. WiFi master controller + Touch panel + DMX driver + Lamp
- 

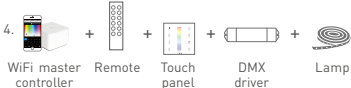
2. Remote + Touch panel + DMX driver + Lamp
- 

4. WiFi master controller + Remote + Touch panel + DMX driver + Lamp

Wireless control

- 

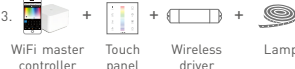
1. Touch panel + Wireless driver + Lamp
- 

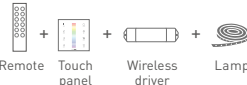
3. WiFi master controller + Touch panel + Wireless driver + Lamp
- 

2. Remote + Touch panel + Wireless driver + Lamp
- 

4. WiFi master controller + Remote + Touch panel + Wireless driver + Lamp

DMX wiring

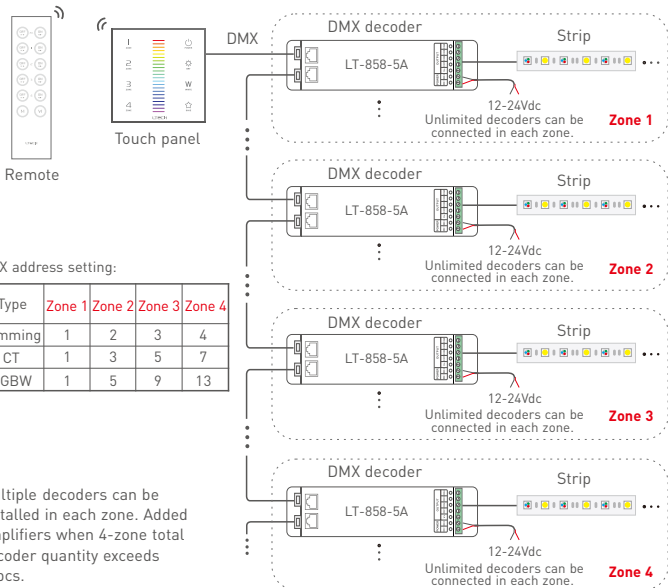

RF wireless wiring



Touch panel

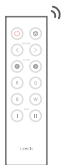

Remote

Multiple wireless receivers (F4-3A/F4-5A/F4-DMX-5A/F5-DMX-4A) can be matched with EX series touch panel within effective distance.

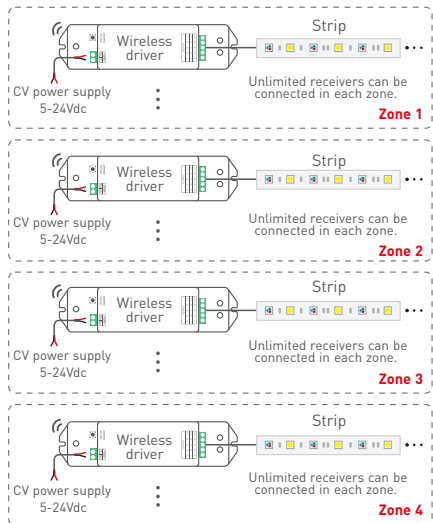

To avoid the signal interference, the installation needs to keep away from the large area metal material or the metal material space.

Multi-panel control wiring

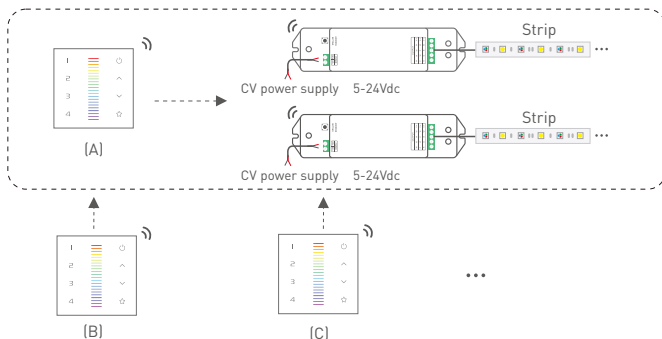

* After touch panel A realizes controlling the lamps, if B and C are matched with A, they can also control the lamps.

* Linkage control is also available at connecting with DMX decoders.

Match code between touch panels

1. Assuming that B matches with A, long press  on B until indicator lights in all zones flicker.



2. Touch the matching zone key on A within 15s, when indicator lights of B stop flicking, match successfully.



Match code between touch panel & remote

1. Long press  on touch panel until all zones' indicator lights flicker.



2. **Match with F series remote:**

Long press On/Off key on F series remote, the indicator light of touch panel stop flickering, match successfully.

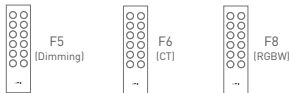

EX5 works with remote F5.

EX6 works with remote F6.

EX8/EX8S works with remote F8.

Match with Q series remote:

Long press the matching zone's "On" key on remote, the indicator light of touch panel stop flicking, match successfully.

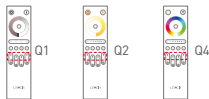

EX5 works with remote Q1.

EX6 works with remote Q2.

EX8/EX8S works with remote Q4.

* Please match/clear code when  indicator light of panel is white.

Match code between touch panel & wireless driver

Touch panels can work with wireless driver F4-3A/F4-5A/F4-DMX-5A/F5-DMX-4A.

Method 1:

1. Power off the driver.



2. Long press On/Off key of the panel until all zone's indicator lights flicking.



3. Power on the driver, the lamps flicker slowly, please complete step 4 within 15s.



4. Short press the matching zone key on the panel, match successful.

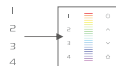

Method 2:

1. Short press "ID learning button" on wireless driver, the lamps flicker, please complete next steps within 15s.



2. Long press On/Off key of the panel until all zone's indicator lights flicking.



3. Short press the matching zone key on the panel, match successful.

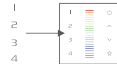

* Please match/clear code when  indicator light of panel is white.

Match code between touch panel & gateway

1. Long press  on touch panel until all zones' indicator lights flicking.



EX5



EX6



EX8



EX8S

2. Turn on APP, enter "zone set" interface, click the right top "MATCH" key, then follow the prompts.



Clear code

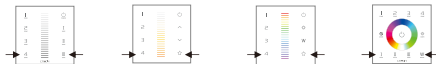

Press the bottom two key on touch panel simultaneously for 6s, the indicator lights flicker several times, clear code successfully.

* Please match/clear code when  indicator light of panel is white.

Warranty agreement:

1. We provide lifelong technical assistance with this product:

- A 5-year warranty is given from the date of purchase. The warranty is for free repair or replacement if cover manufacturing faults only.
- For faults beyond the 5-year warranty, we reserve the right to charge for time and parts.

2. Warranty exclusions below:

- Any man-made damages caused from improper operation, or connecting to excess voltage and overloading.
- The product appears to have excessive physical damage.
- Damage due to natural disasters and force majeure.
- Warranty label, fragile label and unique barcode label have been damaged.
- The product has been replaced by a brand new product.

3. Repair or replacement as provided under this warranty is the exclusive remedy to the customer. LTECH shall not be liable for any incidental or consequential damages for breach of any stipulation in this warranty.

4. Any amendment or adjustment to this warranty must be approved in writing by LTECH only.

* No further notice if any changes in the manual.
Product function depends on the goods.
Please feel free to contact our official distributor if any question.